

Binari Rail

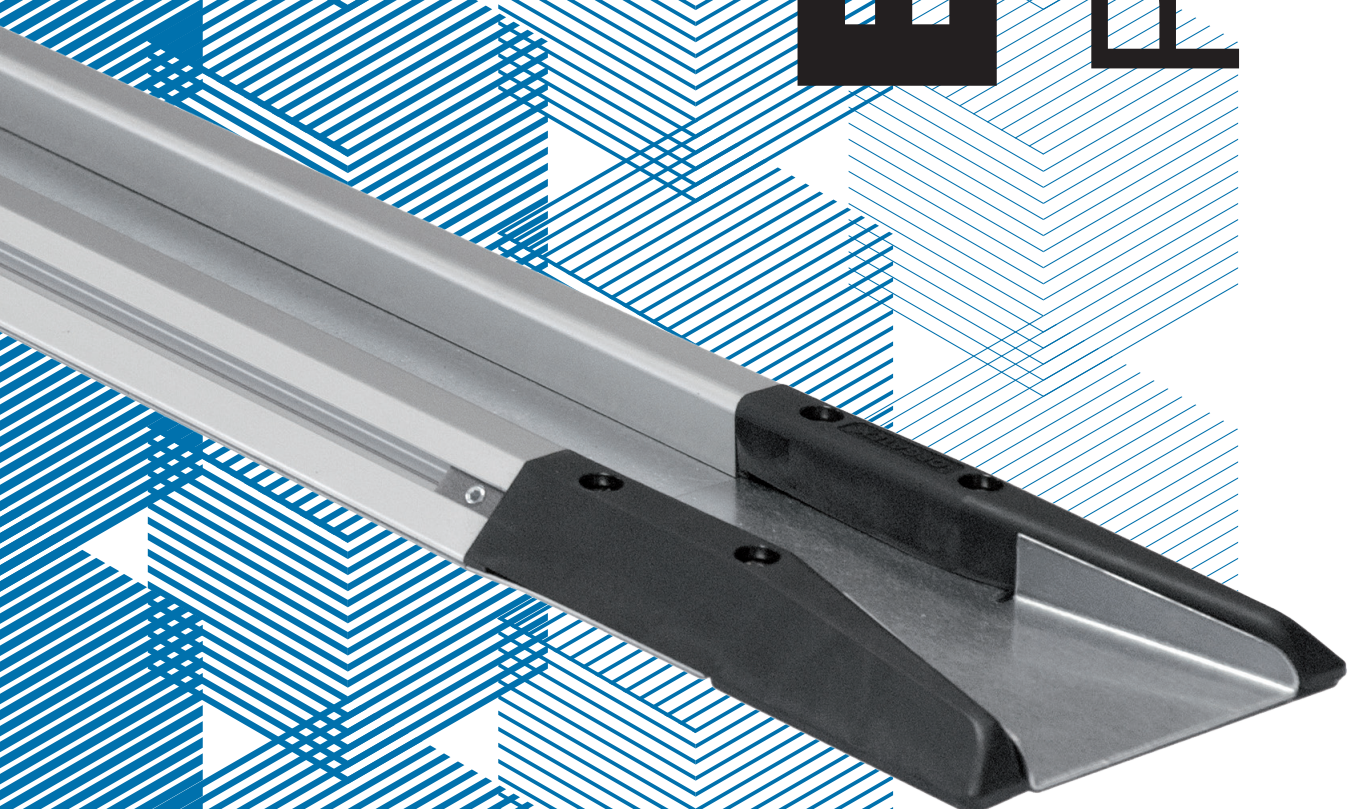

Material Handling

V 4.0

NOTE / NOTES

Material Handling

T +39 0434 572757
info@LeanProducts.eu
www.LeanProducts.eu

LEANPRODUCTS
Lean manufacturing

Index

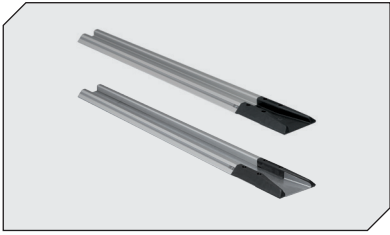

► 4 **FIFO Monorail**

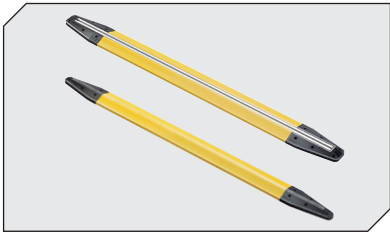

► 14 **Sistema FIFO**
Fifo System

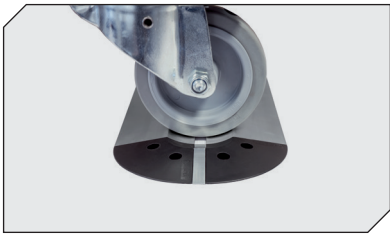

► 22 **PARK Station**

FIFO Monorail

FIFO Monorail 40 mm e 55 mm

FIFO Monorail 40 mm and 55 mm

Material Handling



• Per questioni di sicurezza si raccomanda l'uso di un freno per evitare la fuoriuscita involontaria dei carrelli dalle rotaie.

• It is recommended to use a brake to prevent the rollout of the dollies out of the rails.

FIFO Monorail

FIFO Monorail 40 mm e 55 mm

FIFO Monorail 40 mm and 55 mm



Terminale Fifo Monorail 40 mm / Terminal Fifo Monorail 40 mm

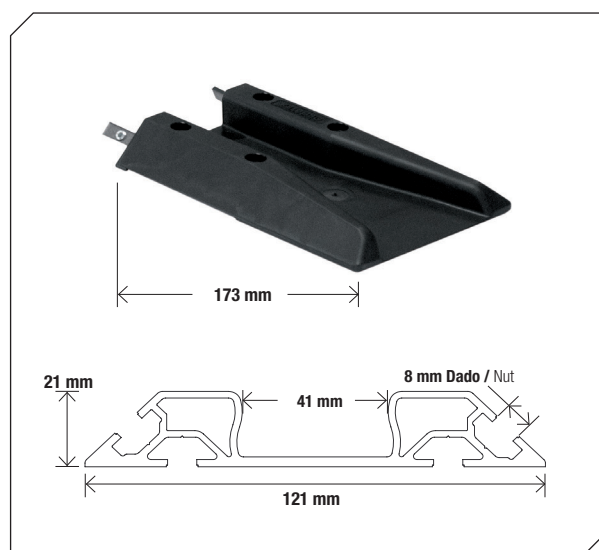

Terminale Fifo Monorail 55 mm / Terminal Fifo Monorail 55 mm

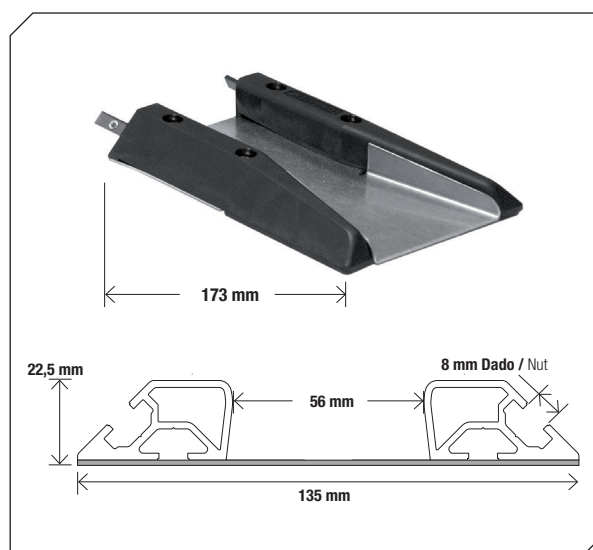

FIFO Monorail

Stazione FIFO Monorail 40 mm e 55 mm

FIFO Monorail Station 40 mm and 55 mm

Material Handling



- Utilizzare piastra di connessione da 400 mm per dolly 600 x 400.
- Utilizzare piastra di connessione da 800 mm per dolly 800 x 600.
- Espandibile sia in larghezza che lunghezza.

- Use connection plate 400 mm for dolly 600 x 400.
- Use connection plate 800 mm for dolly 800 x 600.
- Expandable in length and width.

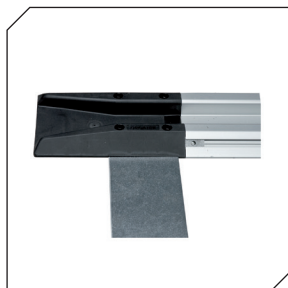
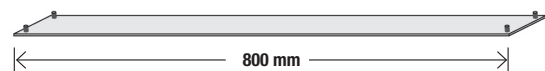

- Esempio di collegamento tra piastra di connessione e terminale.

- Connection Example between connection plate and terminal.

FIFO Monorail

Stazione FIFO Monorail 40 mm e 55 mm

Fifo Monorail Station 40 mm and 55 mm



PRODOTTO PRODUCT	CODE	NOME NAME	Lunghezza Length	Piastra di connessione Connection plate
	MONO-5S-1200	Kit Stazione FIFO-Monorail 40 mm Kit FIFO-Monorail Station 40 mm	1200 mm	400 mm
	MONO-5S-2400	Kit Stazione FIFO-Monorail 40 mm Kit FIFO-Monorail Station 40 mm	2400 mm	400 mm
	MONO-5SVB8-2400	Kit Stazione FIFO-Monorail 55 mm Kit FIFO-Monorail Station 55 mm	2400 mm	800 mm
	DATI TECNICI - 5 rotaie FIFO-Monorail - 10 Terminali FIFO-Monorail neri - 20 viti a brugola - 8 piastre di collegamento	TECHNICAL DATA - 5 rails FIFO-Monorail - 10 black FIFO-Monorail terminals - 20 allen screws - 8 connecting plates		

FIFO Monorail

Stazione FIFO Monorail 40 mm e 55 mm

FIFO Monorail Station 40 mm and 55 mm



Material Handling

■ È possibile realizzare una struttura in profilo di alluminio che permetta di identificare ogni singola corsia.

■ It's possible to an aluminium profile structure that allows to identify every single lane.



■ Cornici informative per sospensione.

■ info frame system.

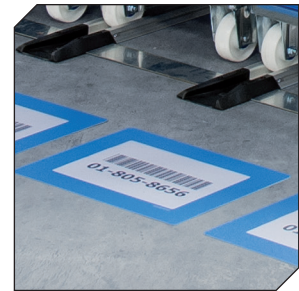

■ LongLife® - Schermo protettivo.



■ LongLife® - Protective screen.

FIFO Monorail

Stazione FIFO Monorail 40 mm e 55 mm

Fifo Monorail Station 40 mm and 55 mm



PRODOTTO PRODUCT	CODE	NOME NAME
	LP-MSP01	Spalla per FIFO-Monorail FIFO-Monorail pilar
	LPQ-3030	Profilo 30 x 30 30 x 30 profile
	LPQ-3030CAPG	Cappuccio di copertura grigio per profilo 30 x 30 End cup 30 x 30
	CODE	COLOR CODE
		01 02 03 04 05 06 07 08
	PKR-A4-100-	01 02 03 04 05 06 07 08
Vedi catalogo LVM & KS / See LVM & KS catalogue		
	CODE	COLOR CODE
		01 02 03 04 05 06 07 08
	LG-KL-A4-	01 02 03 04 05 06 07 08
Vedi catalogo LVM & KS / See LVM & KS catalogue		

FIFO Monorail

Monorail - Elemento di connessione

Monorail - Connection element

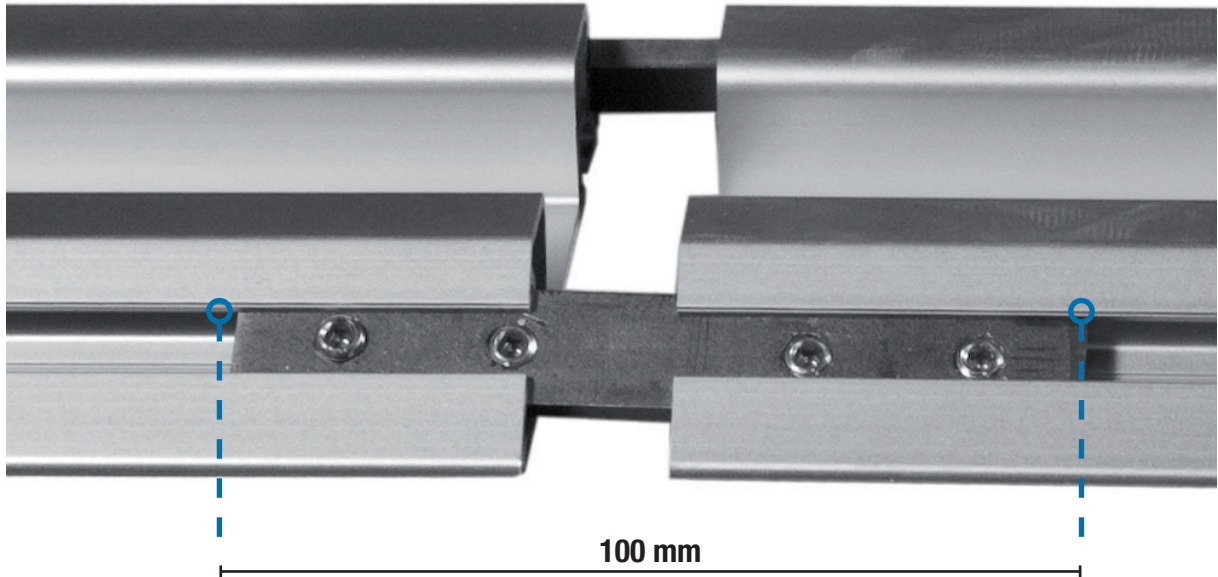
**TECHNICAL DATA**

- Material: Steel
- Dimension: 100 x 15 x 4 mm
- Holes: 4
- Screw: M6 (included)

Monorail - Freno

Monorail - Brake

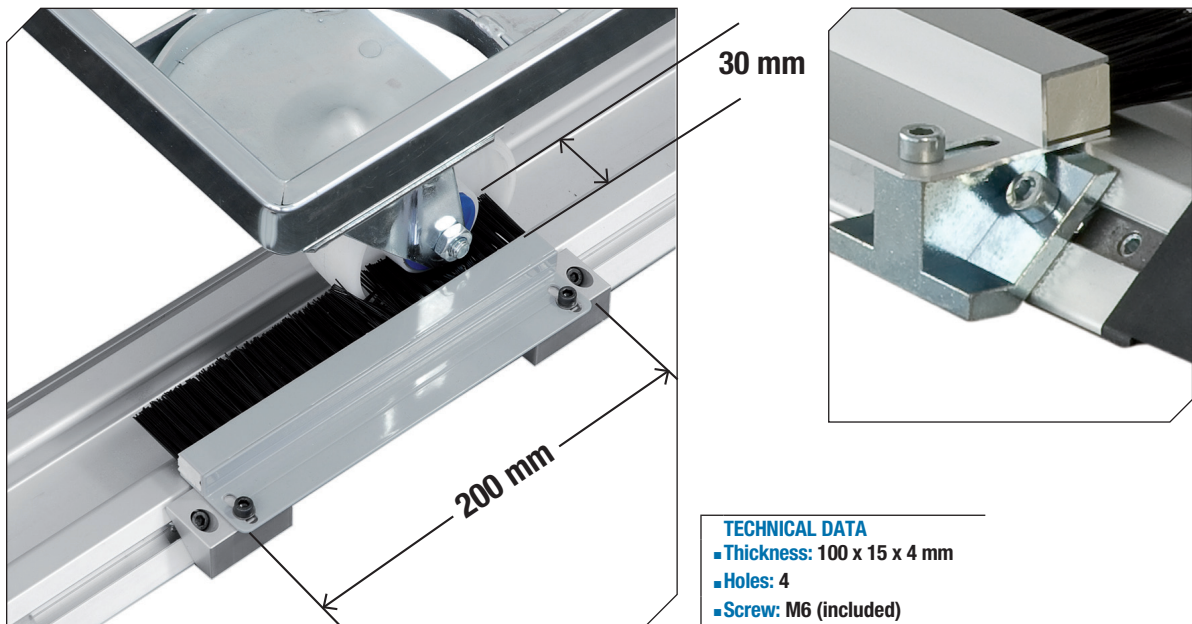
**TECHNICAL DATA**

- Thickness: 100 x 15 x 4 mm
- Holes: 4
- Screw: M6 (included)

FIFO Monorail

Monorail - Freno

Monorail - Brake

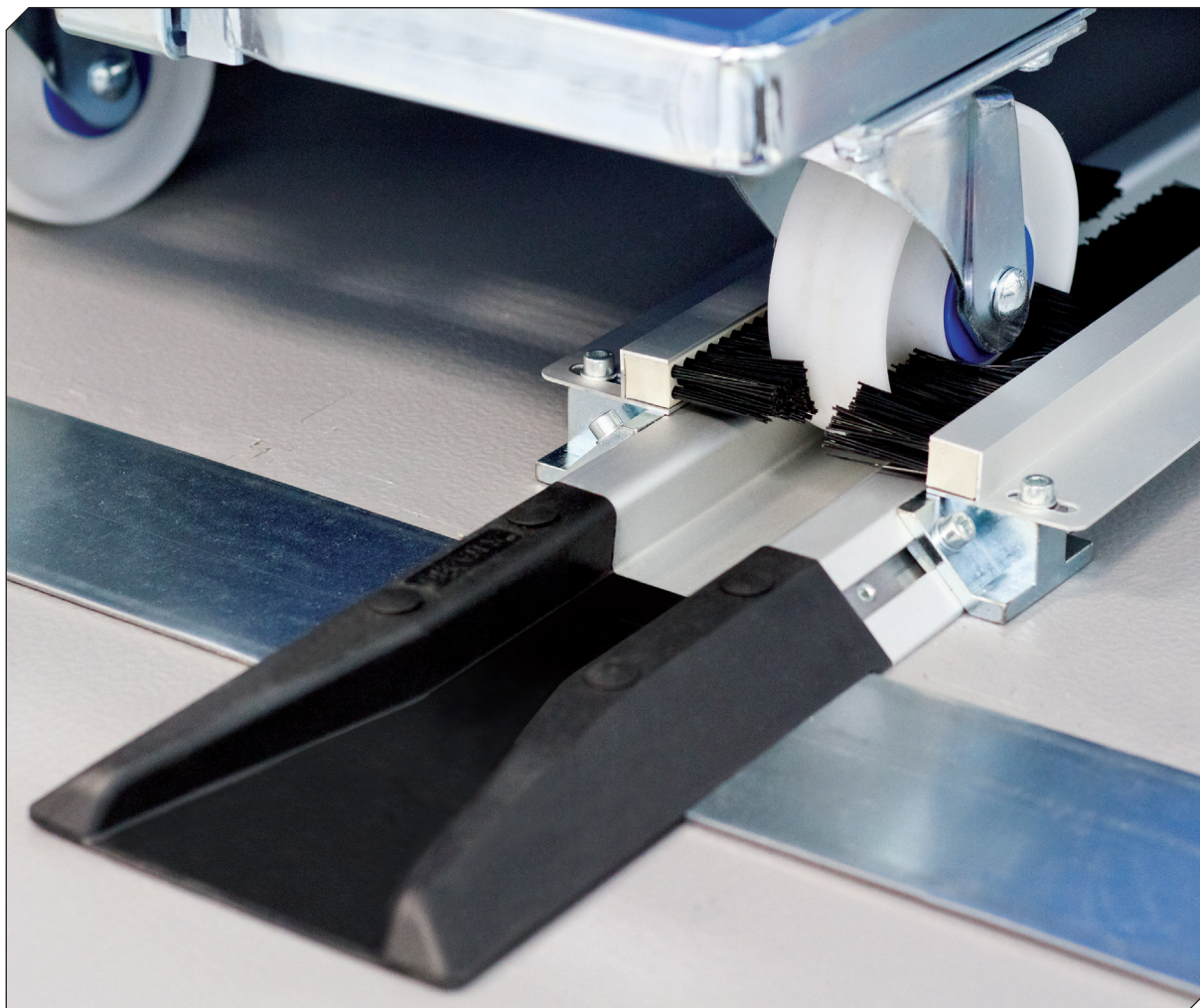

- **Non richiede un processo di sblocco per far transitare i Dolly.**
 - **Minima usura.**
 - **Possibile installazione / rimozione senza alcun tempo di attrezzamento**
 - **Regolazione dell'effetto della frenata.**
 - **Utilizzabile per Monorail 40 mm e 55 mm.**
-
- No unlocking process required before tacking a dolly out of the rail.
 - Minimum wear.
 - Installation / disinstallation without tooling time.
 - Adjustable breaking effect.
 - Suitable for Monorail 40 mm and 55 mm.







FIFO Monorail

Monorail - Componenti

Monorail - Component

Material Handling

PRODOTTO PRODUCT	CODE	NOME NAME	Lunghezza Length	
	MONO-BP-1200	Binario FIFO-Monorail 40 mm FIFO-Monorail Rail 40 mm	1200 mm	5 pezzi 5 pieces
	MONO-BP-1800	Binario FIFO-Monorail 40 mm FIFO-Monorail Rail 40 mm	1800 mm	
	MONO-BP-2400	Binario FIFO-Monorail 40 mm FIFO-Monorail Rail 40 mm	2400 mm	
	MONO-BP-55-1200	Binario FIFO-Monorail 55 mm FIFO-Monorail Rail 55 mm	1200 mm	
	MONO-BP-55-1800	Binario FIFO-Monorail 55 mm FIFO-Monorail Rail 55 mm	1800 mm	
	MONO-BP-55-2400	Binario FIFO-Monorail 55 mm FIFO-Monorail Rail 55 mm	2400 mm	

PRODOTTO PRODUCT	CODE	NOME NAME	
	MONO-EK	Terminale FIFO-Monorail 40 mm FIFO-Monorail Terminal 40 mm	10 pezzi 10 pieces
	MONO-BP-55-EK	Terminale FIFO-Monorail 55 mm FIFO-Monorail Terminal 55 mm	



PRODOTTO PRODUCT	CODE	NOME NAME	
	MONO-EK-AS	Protezione per terminale FIFO-Monorail (viti incluse) Terminal Protection for FIFO-Monorail (screw included)	2 pezzi 2 pieces

PRODOTTO PRODUCT	CODE	NOME NAME	
	MONO-HB	Fissaggio per FIFO-Monorail Fifo-Monorail Rail fixture	2 pezzi 2 pieces
	MONO-HM	Vite per fissaggio per FIFO-Monorail Screw for rail fixture for FIFo-Monorail Rail	1 pezzo 1 piece

FIFO Monorail

Monorail - Componenti

Monorail - Component

PRODOTTO PRODUCT	CODE	NOME NAME	Lunghezza Length	
	MONO-VB	Piastra di connessione per FIFO-Monorail Connection Plate for FIFO-Monorail	400 mm	5 pezzi 5 pieces
	MONO-VB-800	Piastra di connessione per FIFO-Monorail Connection Plate for FIFO-Monorail	800 mm	2 pezzi 2 pieces
	MONO-VB-W45	Piastra di connessione a 45° per FIFO-Monorail Connection Plate with angle 45° for FIFO-Monorail	400 mm	2 pezzi 2 pieces

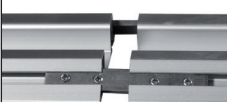
PRODOTTO PRODUCT	CODE	NOME NAME	
	MONO-SV-100	Elemento di connessione FIFO-Monorail (inclusi 40 grani) FIFO-Monorail Connection Element (grub screws included)	10 pezzi 10 pieces

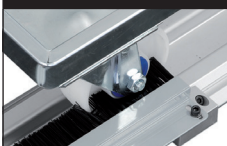
PRODOTTO PRODUCT	CODE	NOME NAME	
	MONO-BBR-200	Freno per FIFO-Monorail FIFO-Monorail Brake	1 pezzo 1 piece

Accessorio

Accessory

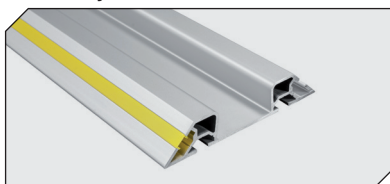

COLORE COLOR	Nero Black	Grigio Grey	Blu Blue	Giallo Yellow	Rosso Red
L= 2000 mm					
CODE	C8 LPQ-CC8N	LPQ-CC8G	LPQ-CC8BL	LPQ-CC8Y	LPQ-CC8R

FIFO System

Sistema FIFO

FIFO System

Material Handling



- Grazie alla sua flessibilità il sistema si adatta a ruote di qualsiasi dimensione e materiale.
- Semplice installazione.
- Maggiore visibilità grazie al color giallo.

- Due to its flexibility the system is suitable for all wheels diameters and truck whidths.
- Easy to install.
- Yellow color for signa effects.

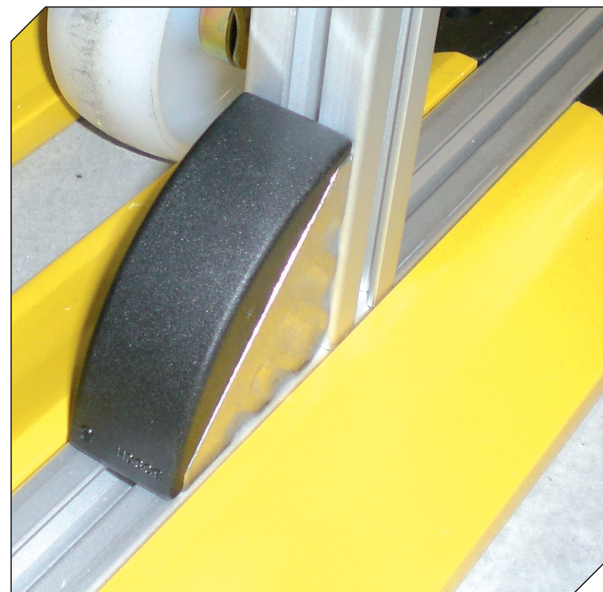

- Dettaglio binario con profilo integrato per montaggio Kanban Buffer.

- Rail detail with integrated profile for Kanban Buffer.

FIFO System

Kanban - Buffer

Kanban - Buffer

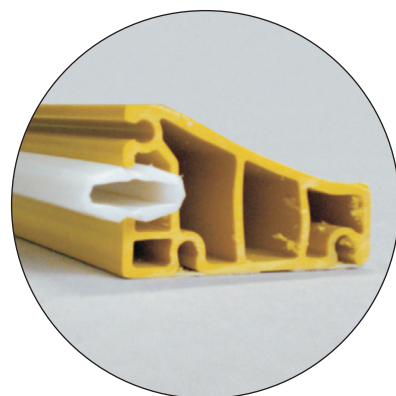

■ Per questioni di sicurezza si raccomanda l'uso di un freno per evitare la fuoriuscita involontaria dei carrelli dalle rotaie.

■ It is recommended to use a brake to prevent the rollout of the dollies out of the rails.

■ Utilizzare l'adattatore per collegare i due binari.

■ Use the adaptor to connect two rails.

FIFO System

Esempi di montaggio

Assembly examples

Material Handling

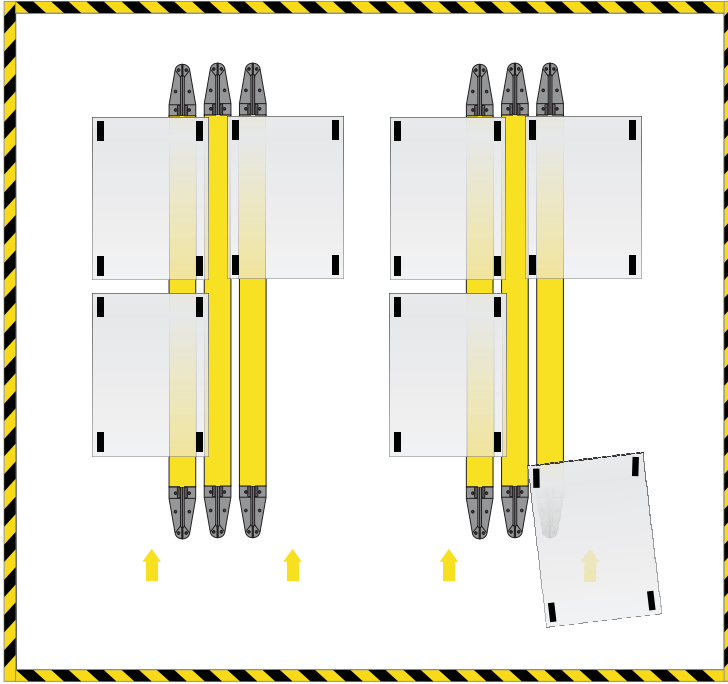

- Utilizabile per dolly con ruote in gomma.
- Suitable for dollies with rubber wheels.

ESEMPIO 1 / EXAMPLE 1

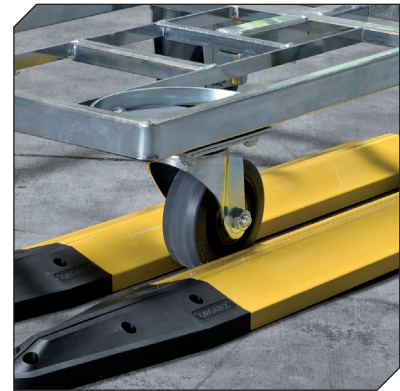

- I dolly vengono guidati solo su un lato.
- Dollies are guided one side.



T +39 0434 572757
 info@LeanProducts.eu
 www.LeanProducts.eu

LEANPRODUCTS
 Lean manufacturing

FIFO System

Esempi di montaggio

Assembly examples

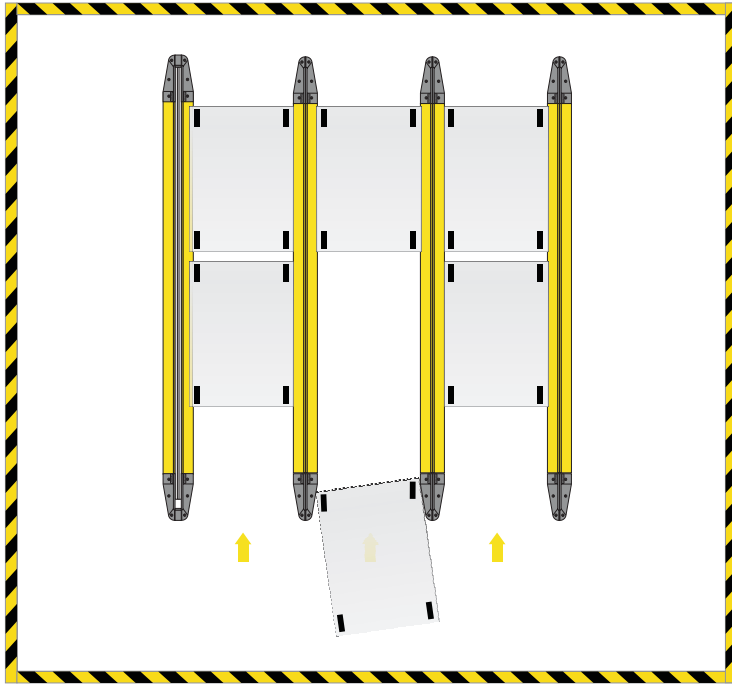

- Utilizabile per dolly con ruote in poliammide.
- Suitable for dollies with polyamide wheels.

ESEMPIO 2 / EXAMPLE 2

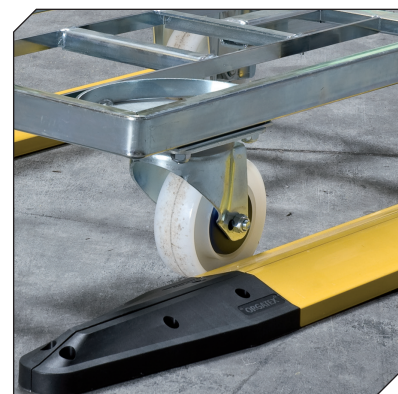

- I dolly vengono guidati su due lati.
- Dollies are guided at the outer side of the wheels.



FIFO System

Kanban - Buffer

Kanban - Buffer

Material Handling

- ▶ **Profilo in alluminio**
vedi catalogo GF-Q
- ▶ Aluminium frame
see GF-Q catalogue

- ▶ **Porta Kanban**
vedi catalogo LVM & KS
- ▶ Kanban envelopes
see LVM & KS catalogue

- ▶ **Contenitori KLT**
vedi catalogo Contenitori
- ▶ Boxes
see Containers catalogue

- ▶ **LongLife® FloorMarking**
vedi catalogo LVM & KS
- ▶ LongLife® FloorMarking
see LVM & KS catalogue



■ Utilizzando il terminale doppio è possibile realizzare una struttura portante con il profilo di alluminio che permette di ottimizzare lo spazio sopra i carrelli per realizzare rulliere a gravità per componenti leggeri, protezioni ed altro.

■ With the double terminal it is possible to create an aluminium profile structure to optimize the space over the dollies to implement gravity rollers for lightweight products, protections and more.

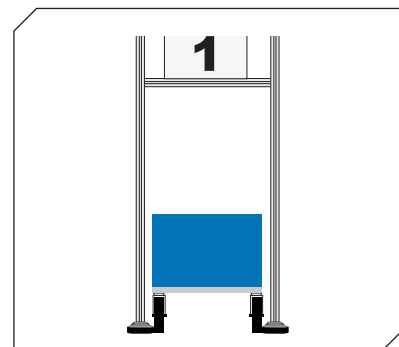

FIFO System

Esempi di utilizzo

Using examples

1

•Montaggio binario FIFO
con terminale singolo.

•FIFO assembly with single terminal.

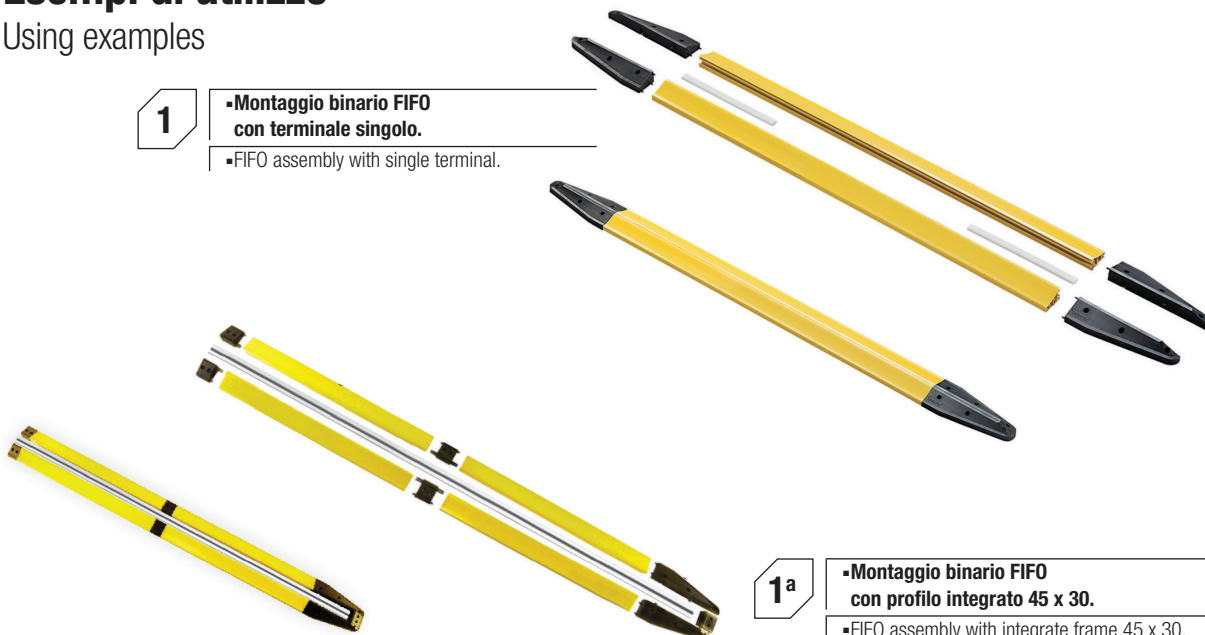

1a

•Montaggio binario FIFO
con profilo integrato 45 x 30.

•FIFO assembly with integrate frame 45 x 30.



2 •Togliere la pellicola di protezione del nastro adesivo nella parte posteriore.

•Remove the protective film from the tape on the backside.



3 •Posizionare il binario nella posizione desiderata e premere con forza.

•Place the rail in the desired position and press firmly.



4 •Affiancare le ruote del carrello al binario.

•Place the dolly's wheels beside the rail.



5 •Posizionare il binario secondario e fissarlo.

•Place the second rail and fix it.



6 •Fissare in maniera definitiva i terminali al pavimento utilizzando viti e tasselli.

•Fix the terminals to the floor using raw plugs and screws.

FIFO System

Sistema FIFO - Componenti

FIFO System - Component

PRODOTTO PRODUCT	CODE	NOME NAME	Lunghezza Length	
	FIFO-BP-1200	Binario / Rail	1200 mm	1 pezzo 1 piece
	FIFO-BP-1800	Binario / Rail	1800 mm	
	FIFO-BP-2400	Binario / Rail	2400 mm	
	FIFO-BP-3000	Binario / Rail	3000 mm	
Altre lunghezze fino a max. 3 m disponibili a richiesta Other lengths up to max. 3 m available on request				

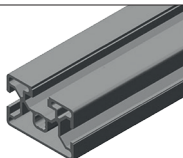
PRODOTTO PRODUCT	CODE	NOME NAME
	LPQ-3030	Profilo in alluminio 30 x 30 Aluminium profile 30 x 30
Da utilizzare con terminale doppio FIFO-EK-1 Use with Doble terminal FIFO-EK-1		
	LPQ-4530	Profilo in alluminio 45 x 30 Aluminium profile 45 x 30
Da utilizzare con distanziale per profilo 45 x 30 FIFO-EKV Use with Spacer for 45 x 30 frame FIFO-EKV		

PRODOTTO PRODUCT	CODE	NOME NAME	
	FIFO-ADAPTER	Adattatore per binario Rail adapter	N° 5 x 250 mm
Adattatore per unire i binari Adapter for rails junction			

PRODOTTO PRODUCT	CODE	NOME NAME	Lunghezza Length	
	FIFO-EK-2L	Terminale sinistro Left terminal	225 mm	1 pezzo 1 piece
	FIFO-EK-2R	Terminale destro Right terminal	225 mm	
Agevolatore per ingresso binario con 3 fori di fissaggio Facilitator for rail access with 3 fixing holes				

FIFO System

Sistema FIFO - Componenti

FIFO System - Component

PRODOTTO PRODUCT	CODE	NOME NAME		
	FIFO-EK-1	Terminale doppio Double terminal	L= 225 mm	1 pezzo 1 piece
	Agevolatore per ingresso binario per integrazione profilato (30 x 30) con 6 fori per il fissaggio Facilitator for rail access with 6 fixing holes			

PRODOTTO PRODUCT	CODE	NOME NAME		
	FIFO-PAK-L	Terminale corto sinistro Left short terminal	45 x 50 x 30 mm	10 pezzi 10 pieces
	FIFO-PAK-R	Terminale corto destro Right short terminal	45 x 50 x 30 mm	
	Con 2 fori per il fissaggio With 2 fixing holes			

PRODOTTO PRODUCT	CODE	NOME NAME		
	FIFO-PV	Terminale sinistro Left terminal	45 x 50 x 30 mm	10 pezzi 10 pieces
	Con 2 fori per il fissaggio With 2 fixing holes			

PRODOTTO PRODUCT	CODE	NOME NAME		
	FIFO-EKV	Distanziale per profilo 45 x 30 Spacer for 45 x 30 floor	45 x 50 x 30 mm	10 pezzi 10 pieces
	Con 2 fori per il fissaggio With 2 fixing holes			

PRODOTTO PRODUCT	CODE	NOME NAME		
	FIFO-SCHR-K	Vite per fissaggio 6 x 40 mm Fixing screw 6 x 40 mm		20 pezzi 20 pieces
	Consigliata per fissaggio a terra Recommended for floor fixing			

PARK Station

Park Station in plastica con terminali

Park Station plastic rail with end cup

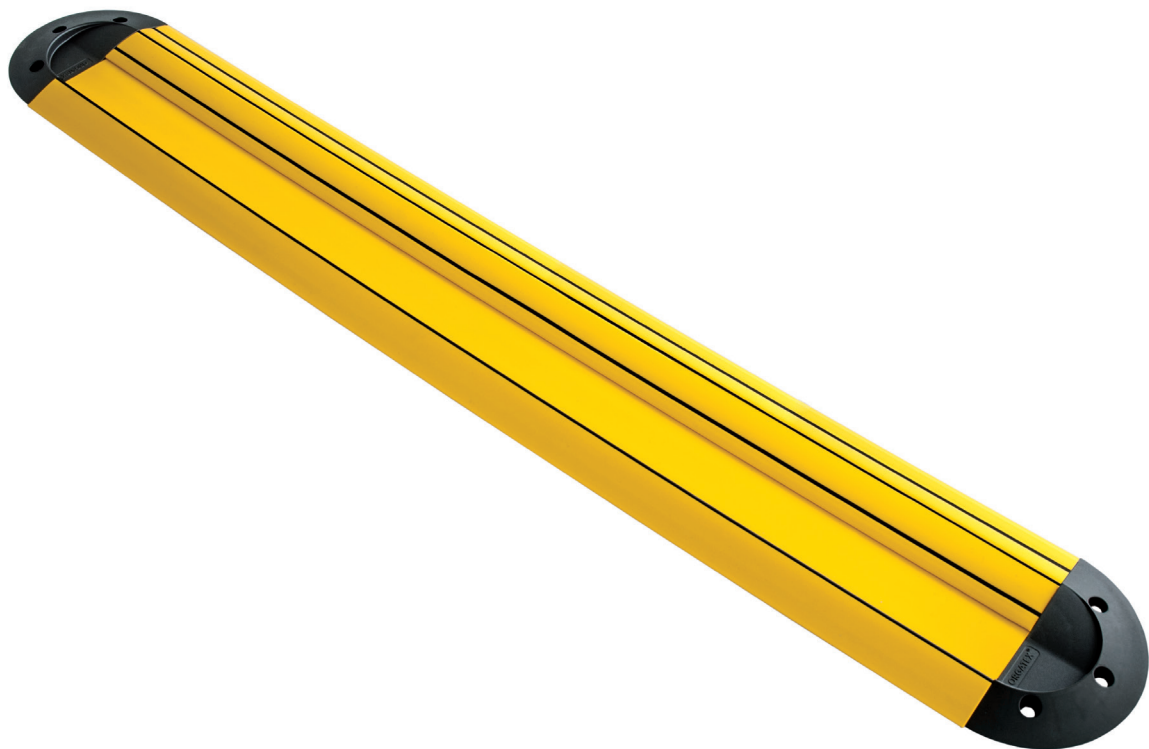
Material Handling

- Questi binari possono essere utilizzati sia in reparti produttivi che in reparti di stoccaggio. Il nuovo design del park station adesivo permette lo stazionamento dei dolly nella posizione stabilita.
- Si adatta a qualsiasi dimensione di ruota.
- Si adatta a ruote di qualsiasi materiale.
- Facile applicazione (adesivo).
- Facile da tagliare.

- There rails can be used both in production and storage areas with the new design of adhesive Park Station, dollies. Dollies remain in the desired position.
- It fits every wheel diameter.
- It fits to every wheel material.
- Ready to use (industrial adhesive).
- Easy to cut.



- Si adatta a qualsiasi dimensione di ruota.
- It fits every wheels diameter.

PARK Station

Park Station in plastica con terminali

Park Station plastic rail with end cup



PRODOTTO PRODUCT	CODE	NOME NAME	Lunghezza Length	
	PAB-KU-400	Binario Park Station in plastica Park Station Plastic Rail	400 mm	5 pezzi 5 pieces
	PAB-KU-800	Binario Park Station in plastica Park Station Plastic Rail	800 mm	
	PAB-KU-1200	Binario Park Station in plastica Park Station Plastic Rail	1200 mm	
	PAB-KU-2400	Binario Park Station in plastica Park Station Plastic Rail	2400 mm	

PRODOTTO PRODUCT	CODE	NOME NAME	
	PAB-KU-EK	Terminale per binario Park Station in plastica End caps for Park Station plastic rail	10 pezzi (5dx + 5sx) 10 pieces (5dx + 5sx)
		Adesivo Self-adhesive	

PARK Station

Park Station con terminali

Park Station with end cup

Material Handling

- Park Station con LongLife® FloorMarking per una migliore segnalazione.
- Parking Slot with LongLife® FloorMarking optionally usable for signal effect.

- Disponibile in due altezze e larghezze.
- Adesivo.
- Preciso approvvigionamento del materiale.
- Estremamente resistente.
- Facile da installare.
- Permette lo stazionamento dei dolly nella posizione stabilita.

- Available in two heights and different widths.
- Self-adhesive.
- Precise provision of material.
- Extremely resistant.
- Easy to install.
- Dollies remain in the desired position.





PARK Station

Stazione Park Station

Park Station



PRODOTTO PRODUCT	CODE	COLOR CODE							
		01	02	03	04	05	06	07	08
	PKR-A4-100-	01	02	03	04	05	06	07	08
	Vedi catalogo LVM & KS / See LVM & KS catalogue								
		01	02	03	04	05	06		08
	LG-KL-A4-	01	02	03	04	05	06		08
	Vedi catalogo LVM & KS / See LVM & KS catalogue								
		COLOR CODE							
		SG	BW	GW	RW	SW			
	LG50-	SG	BW	GW	RW	SW			
Vedi catalogo LVM & KS / See LVM & KS catalogue									

FIFO System

Combinazioni Park Station

Park Station combination

- Alto-Alto.
- High-High.

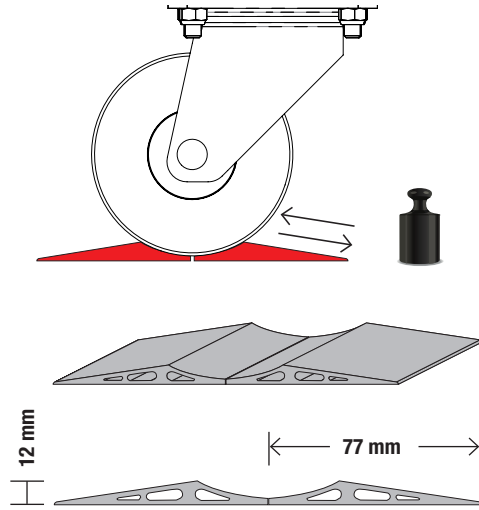
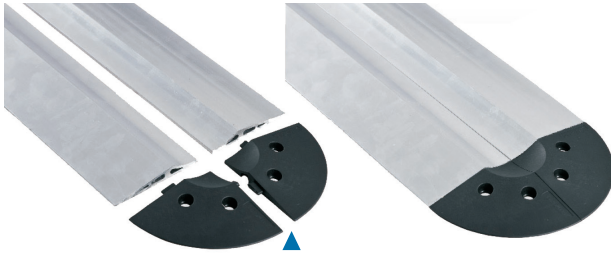

- ▶ Terminale
- ▶ Terminal

- Alto-Basso.
- High-Low.

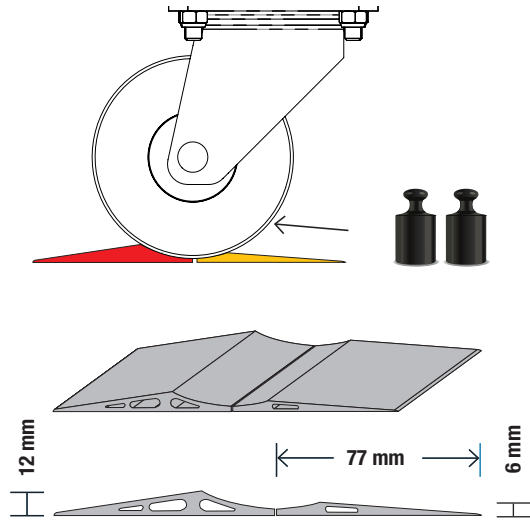
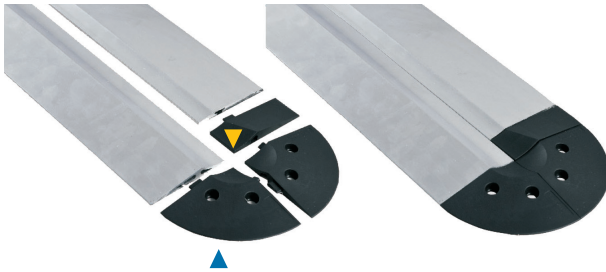

- ▶ Terminale
- ▶ Terminal
- ▶ Adattatore per binario ribassato
- ▶ Low rail connector adapter

- Basso-Basso.
- Low-Low.

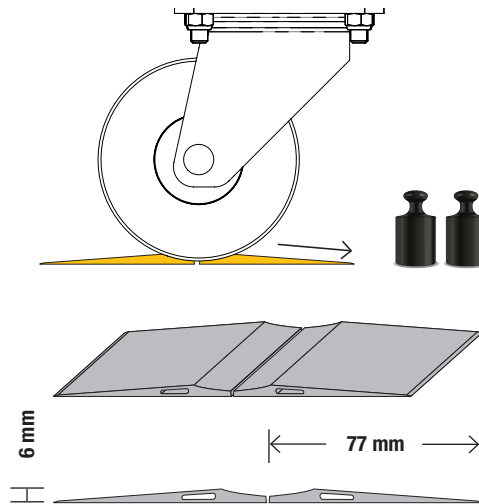
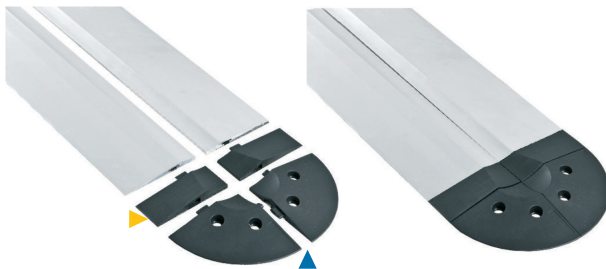

- ▶ Terminale
- ▶ Terminal
- ▶ Connettore per terminale
- ▶ Terminal connector

FIFO System

Park Station per ruote con diverso diametro

Park Station for wheels with different diameter

- Per ruote fino a 100 mm.
- For wheels up to 100 mm.

Componenti / Components



- Per ruote oltre 100 mm.
- For wheels bigger than 100 mm.

Componenti / Components

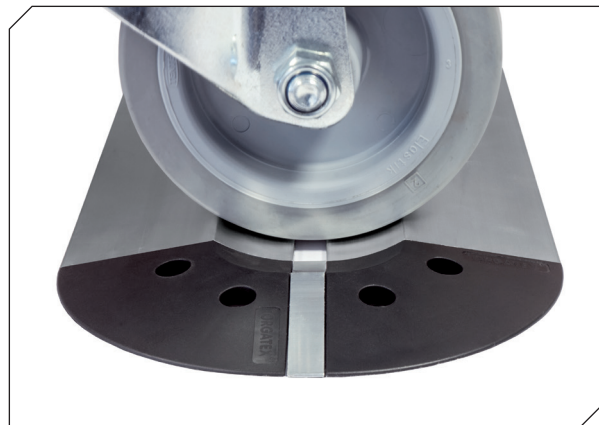

- ▶ Distanziali in alluminio per allargare la Park Station.
- ▶ Aluminum spacers to enlarge the Park Station.





- Utilizzare il distanziale Park Station per adattare il binario alla dimensione della ruota.
- Using Park Station spacer to adapt the rail to the wheel dimension.

FIFO System

Binari Park Station in alluminio

Park Station aluminium rails

PRODOTTO PRODUCT	CODE	NOME NAME	Lunghezza Length	
	PAB-400	Binario Park Station in alluminio Park Station aluminium rail	400 mm	2 pezzi 2 pieces
	PAB-800	Binario Park Station in alluminio Park Station aluminium rail	800 mm	
	PAB-1200	Binario Park Station in alluminio Park Station aluminium rail	1200 mm	
	PAB-2400	Binario Park Station in alluminio Park Station aluminium rail	2400 mm	

PRODOTTO PRODUCT	CODE	NOME NAME	Lunghezza Length	
	PAB-FH-400	Binario Park Station in alluminio, basso-alto Adattatori inclusi Park Station aluminium rail, low-high, Adapters included	400 mm	2 pezzi 2 pieces
	PAB-FH-800	Binario Park Station in alluminio, basso-alto Adattatori inclusi Park Station aluminium rail, low-high Adapters included	800 mm	
	PAB-FH-1200	Binario Park Station in alluminio, basso-alto Adattatori inclusi Park Station aluminium rail, low-high Adapters included	1200 mm	
	PAB-FH-2400	Binario Park Station in alluminio, basso-alto Adattatori inclusi Park Station aluminium rail, low-high Adapters included	2400 mm	

PRODOTTO PRODUCT	CODE	NOME NAME	Lunghezza Length	
	PAB-F-400	Binario Park Station in alluminio, basso-basso Adattatori inclusi Park Station aluminium rail, low-low Adapters included	400 mm	2 pezzi 2 pieces
	PAB-F-800	Binario Park Station in alluminio, basso-basso Adattatori inclusi Park Station aluminium rail, low-low Adapters included	800 mm	
	PAB-F-1200	Binario Park Station in alluminio, basso-basso Adattatori inclusi Park Station aluminium rail, low-low Adapters included	1200 mm	
	PAB-F-2400	Binario Park Station in alluminio, basso-basso Adattatori inclusi Park Station aluminium rail, low-low Adapters included	2400 mm	

PRODOTTO PRODUCT	CODE	NOME NAME	
	PAB-UGS2	Adattatore per binario ribassato Low rail connection adapter	2 pezzi 2 pieces
	PAB-UGS4	Adattatore per binario ribassato Low rail connection adapter	4 pezzi 4 pieces

PRODOTTO PRODUCT	CODE	NOME NAME	Larghezza Width	
	PAB-ZW2	Distanziale Park Station alluminio Aluminium Park Station spacer	20 mm	2 pezzi 2 pieces
	PAB-ZW3	Distanziale Park Station alluminio Aluminium Park Station spacer	30 mm	
	PAB-ZW4	Distanziale Park Station alluminio Aluminium Park Station spacer	40 mm	

PRODOTTO PRODUCT	CODE	NOME NAME	
	PAB-EK1	Terminale Laterale Park Station Park Station side terminal	4 pezzi 4 pieces

NOTE / NOTES

Material Handling

T +39 0434 572757
info@LeanProducts.eu
www.LeanProducts.eu

LEANPRODUCTS
Lean manufacturing



LEANPRODUCTS®

Lean manufacturing

T +39 0434 572757
info@LeanProducts.eu

www.LeanProducts.eu